

CREATE
YOUR STYLE
with SWAROVSKI ELEMENTS

DESIGN GUIDE
KIDS SPECIAL
CAT HAIR BAND





... purrrrr-fect summertime project!

CAT HAIR BAND



Swarovski Elements

Article	Product Group	Article No.	Amount	Size	Color	Color Code
	Sew-on Stones	3254	2 pcs.	20x9 mm	Olivine	228
	Beads	5742	1 pc.	8 mm	Siam	208

Supplies & Tools

Supplies

- 10x20cm Cotton, pink-white
- Dacron, white
- 0.5m Embroidery thread, green
- 1.5m Embroidery thread, white
- 1 Hair band, violet
- 1m Nylon thread, transparent - 0.15mm
- Sewing silk, white

Tools

- Double sided sticky tape
- Embroidery needle
- Needle
- Pins
- Scissors
- Sewing machine
- 1 Sheet of paper, DIN A4
- Tweezers

STEP 1: Print pattern and cut out cat's head along red outline.

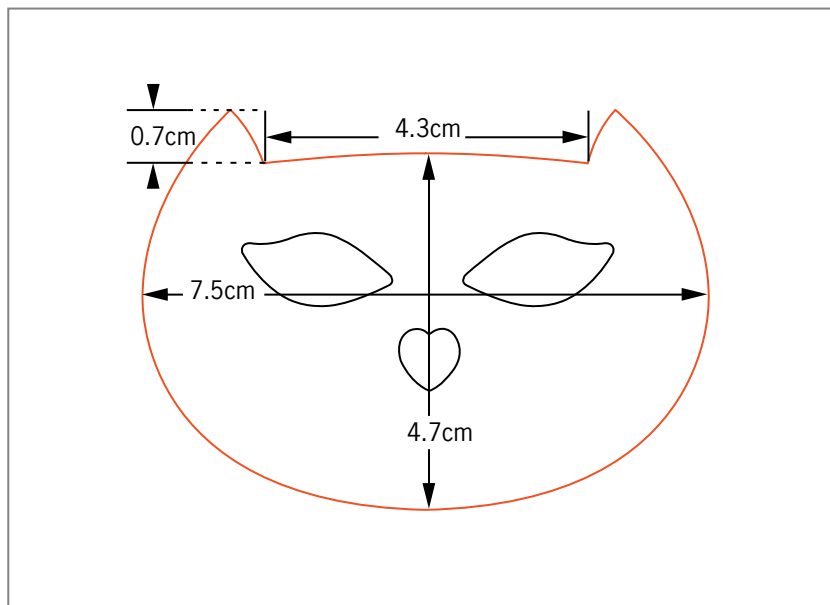

STEP 2: Stick pattern with some doubled sided sticky tape onto the cotton fabric and cut out making the pattern 3mm larger than pattern outline. Remove pattern from fabric.

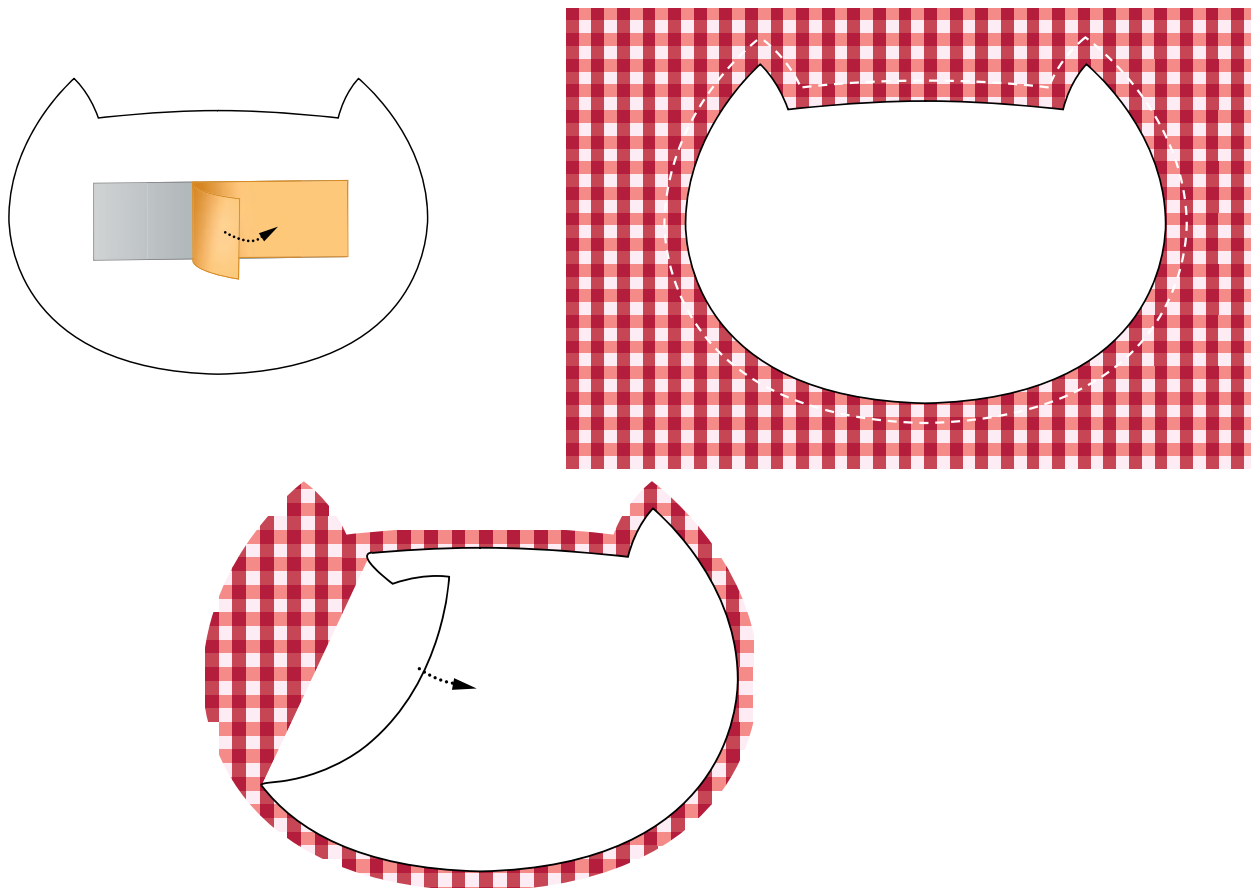

STEP 3: Lay the first cut out onto another piece of cotton fabric and cut out the second fabric piece. Attach the two pieces with pins and sew them together with a sewing machine using the white sewing silk. Leave a small space that is not sewn as you see in the illustration.

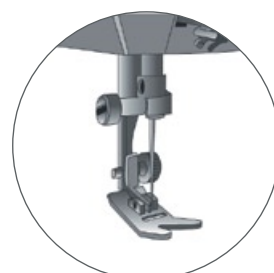
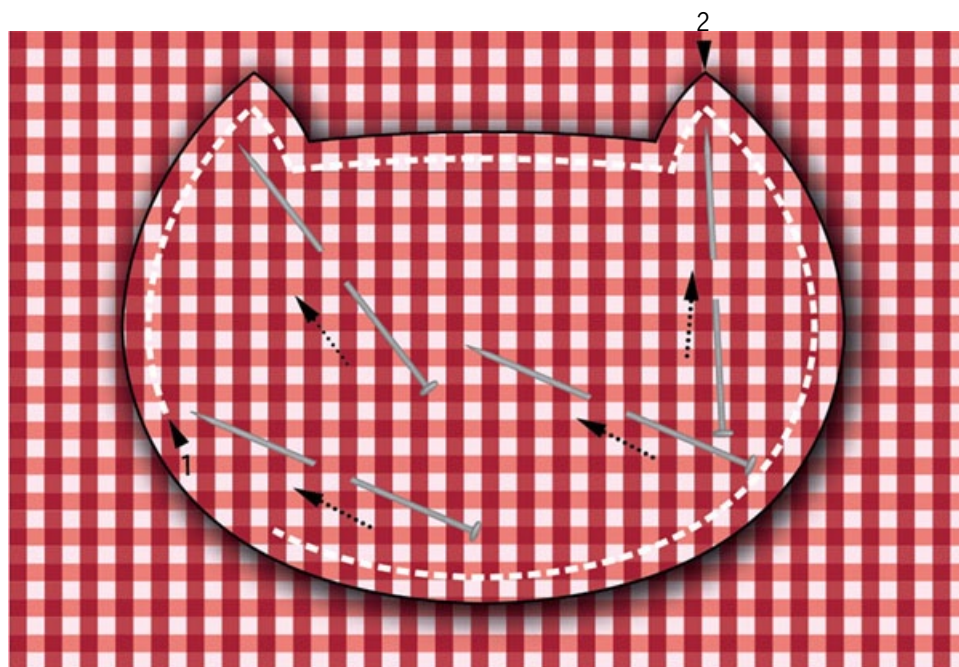

1



2

STEP 4 : Fill the head with some Dacron using tweezers. Sew the opening closed and cut off excess thread.

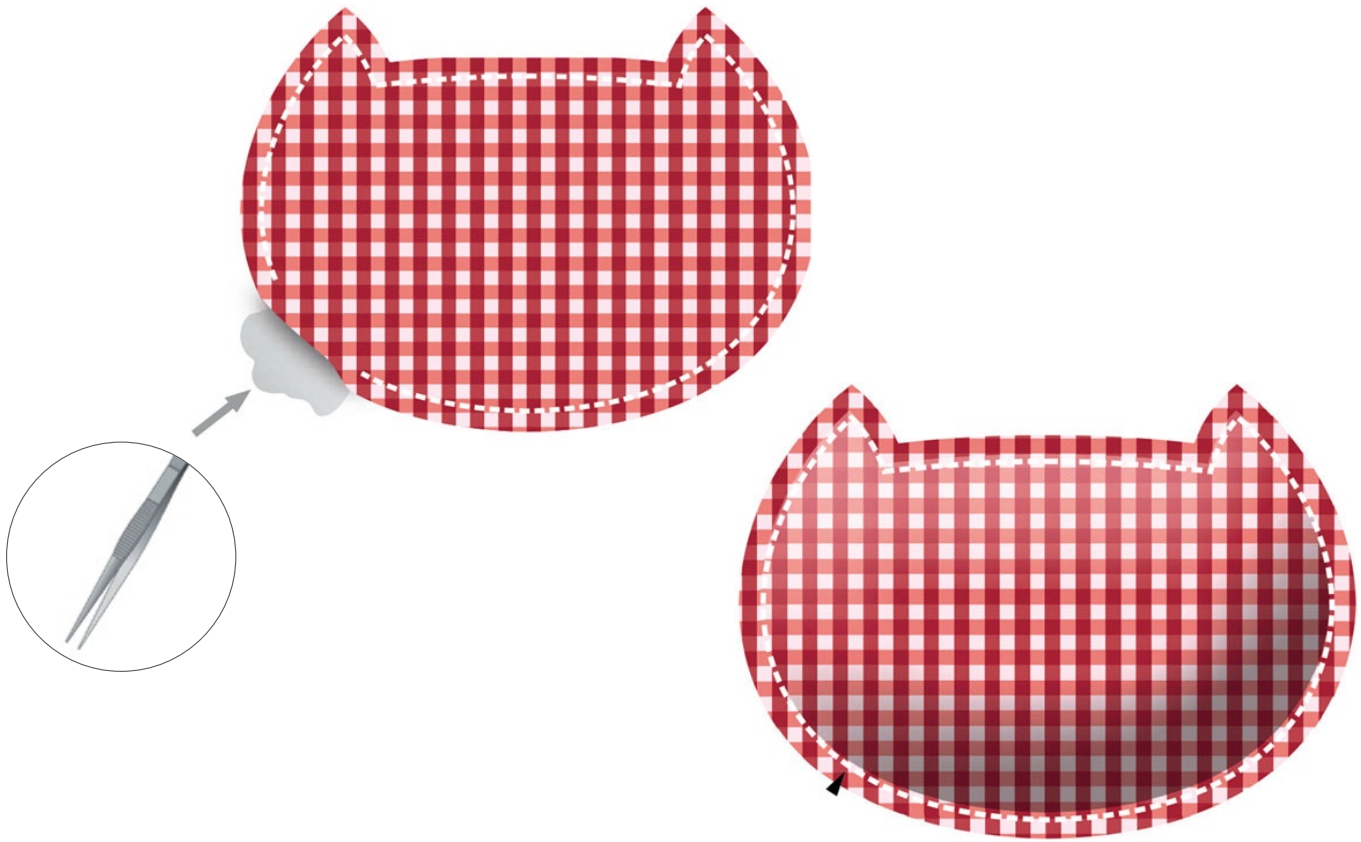

STEP 5 : Cut 1m of 0.15mm nylon thread. Attach the SWAROVSKI ELEMENTS Sew-on Stones with some pins onto cat's head as shown. Sew the nylon thread once through the fabric and the through the first hole of the Sew-on Stone and knot both nylon thread ends afterwards.

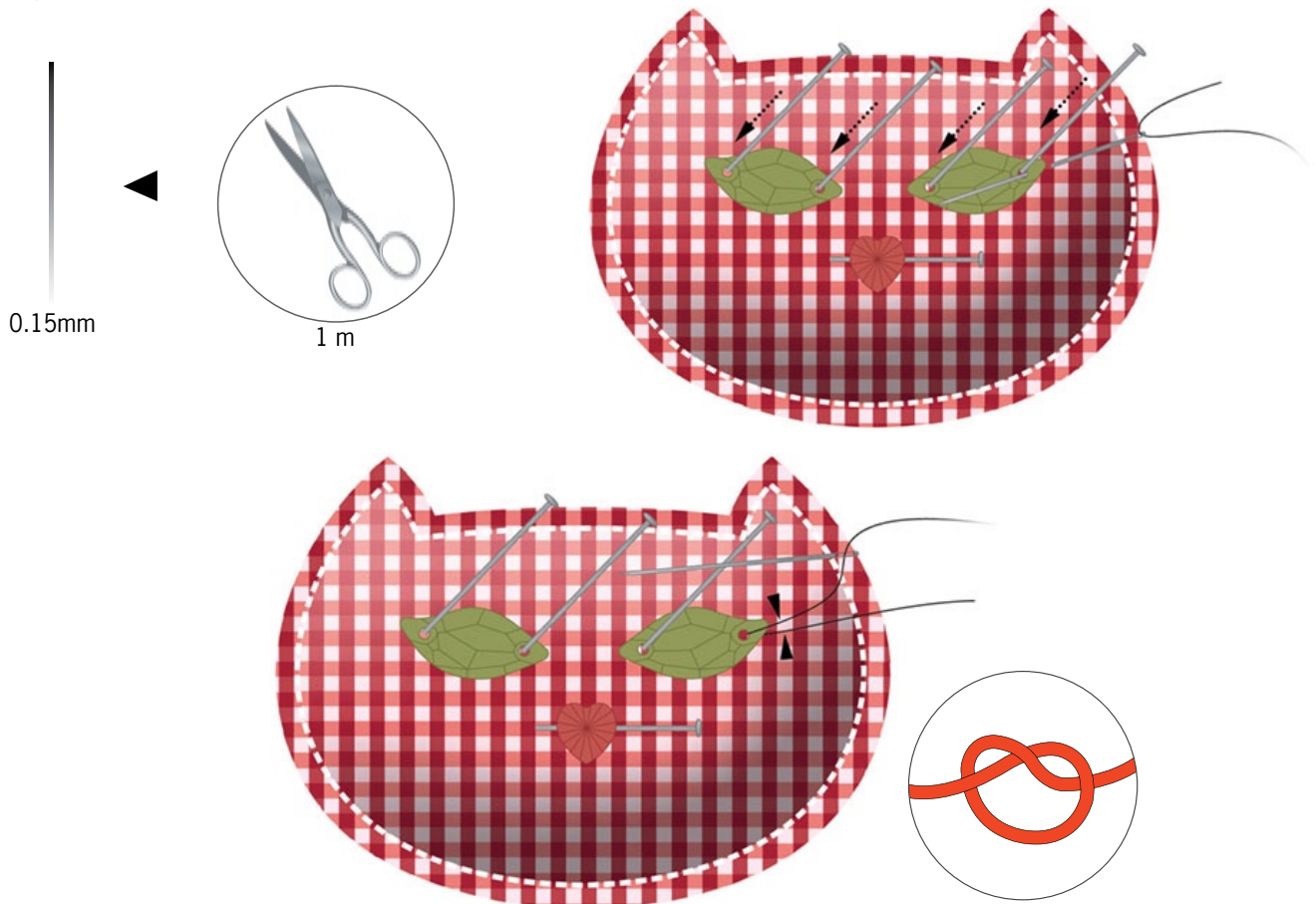

STEP 6 : Sew through the same hole four times, then stitch to next hole and repeat to attach the first SWAROVSKI ELEMENTS Sew-on Stone.

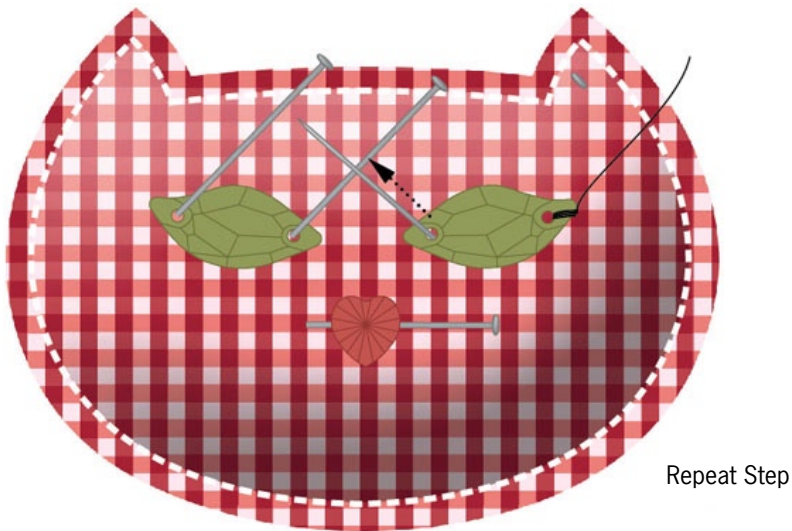
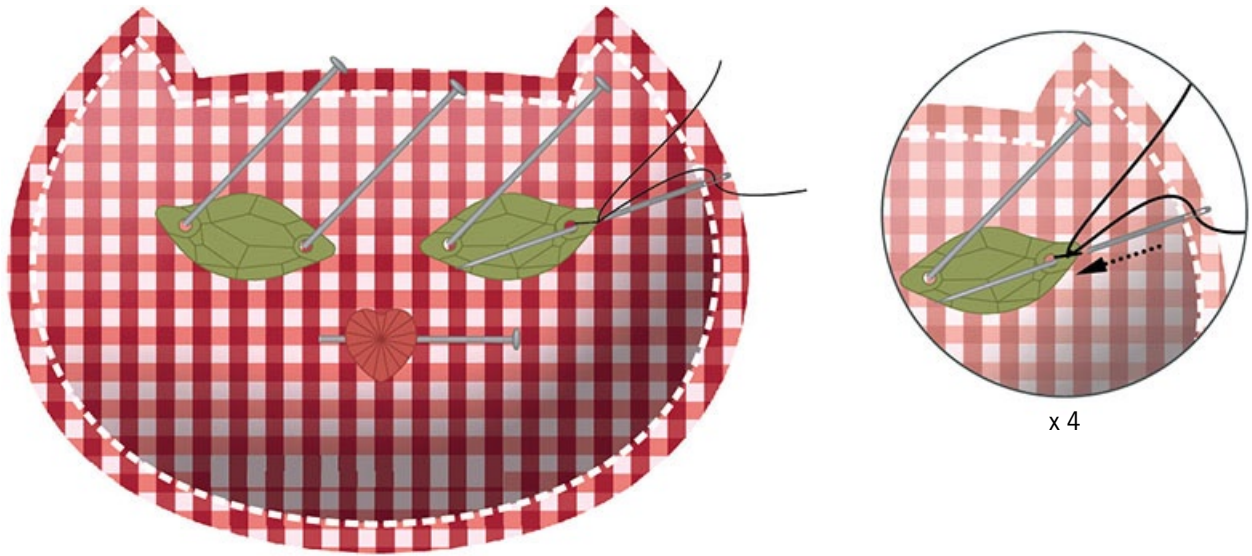

STEP 7 : Repeat step 6 twice to attach second Sew-on Stone and SWAROVSKI ELEMENTS Heart Bead. Make 4 back stitches to attach the nylon thread and cut off both thread ends.

Repeat step 6 x2

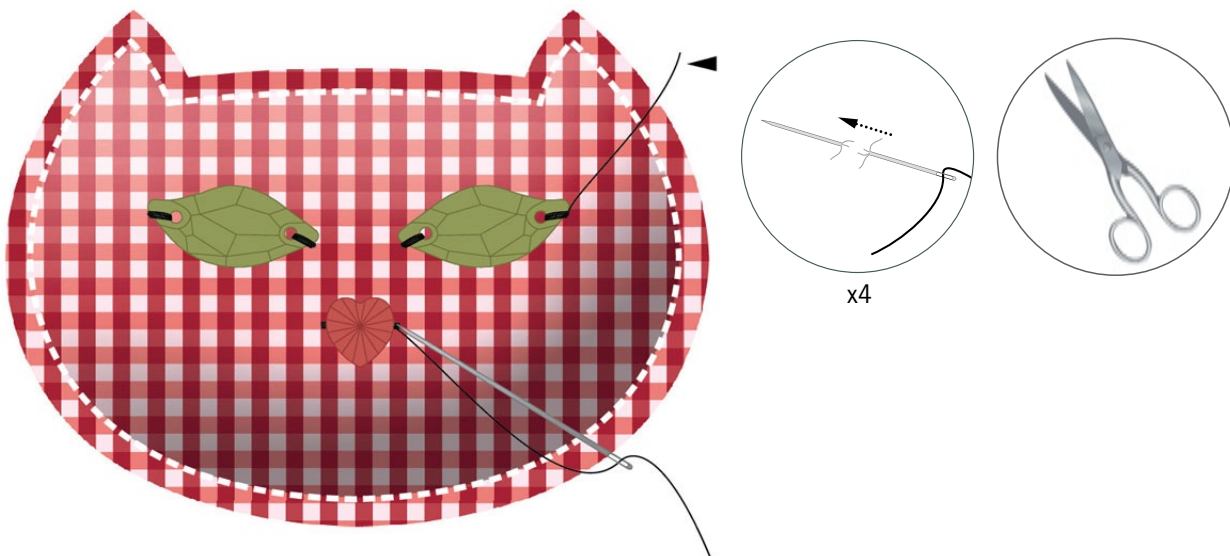

STEP 8 : Cut 0.5m of green embroidery thread and fix thread with 4 back stitches which are hidden under the SWAROVSKI ELEMENTS Heart Bead.

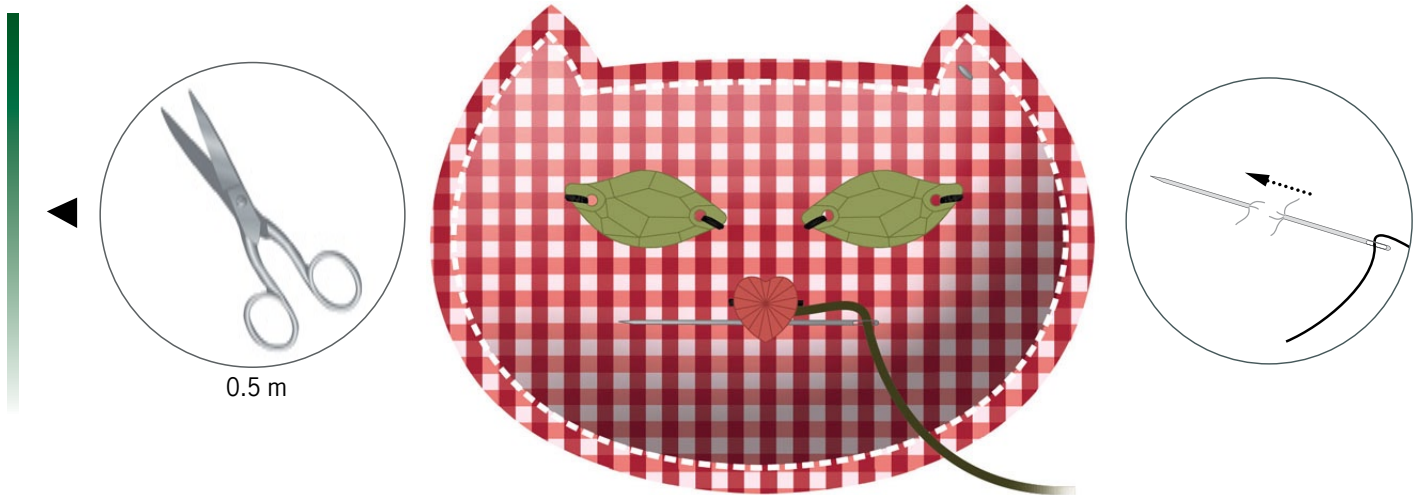

STEP 9 : Embroider as you see in the illustration and attach the thread at the end with some back stitches then cut off the thread ends.

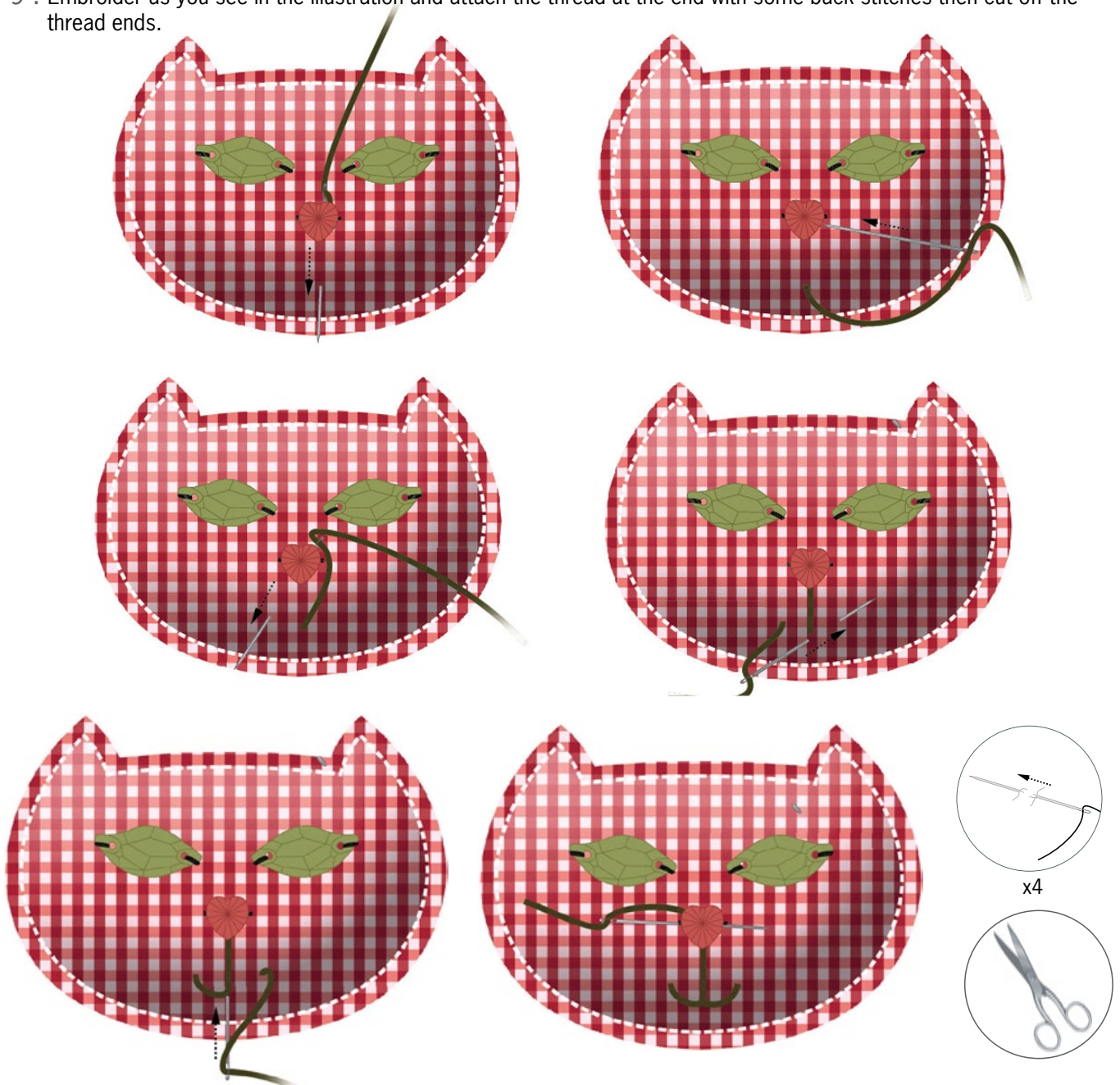

STEP 10: Cut 0.5m of white embroidery thread and make a stitch to form whiskers. Cut off thread after stitch and repeat to make three whiskers on each side.

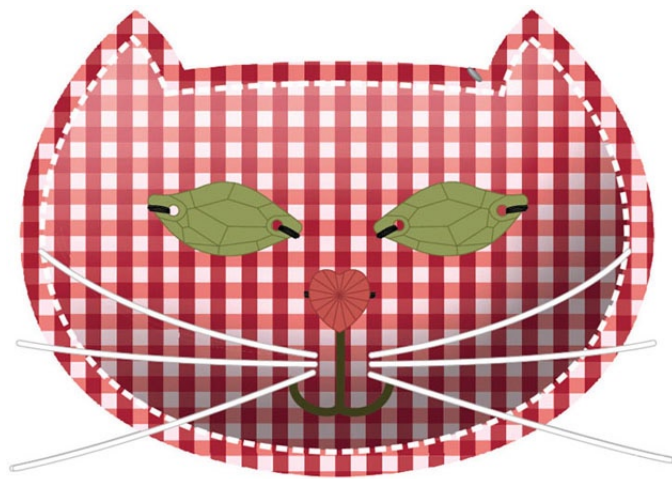
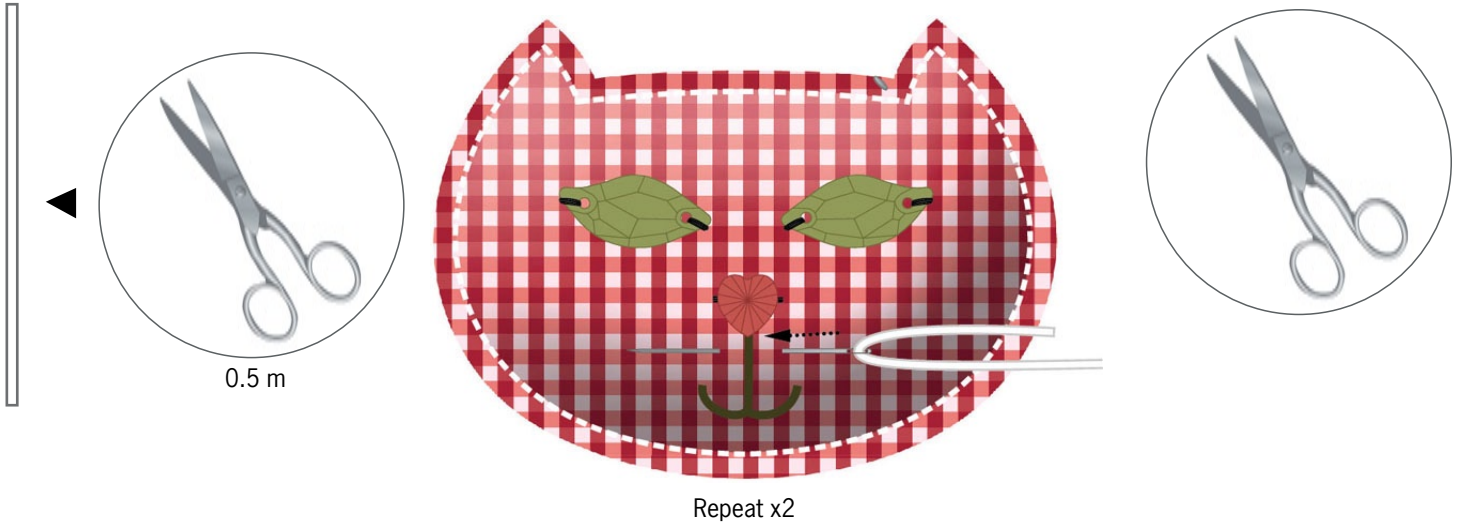

STEP 11: Cut 1m of white embroidery thread and fix thread with 4 back stitches on back side of cat's head and wrap thread five times around headband.

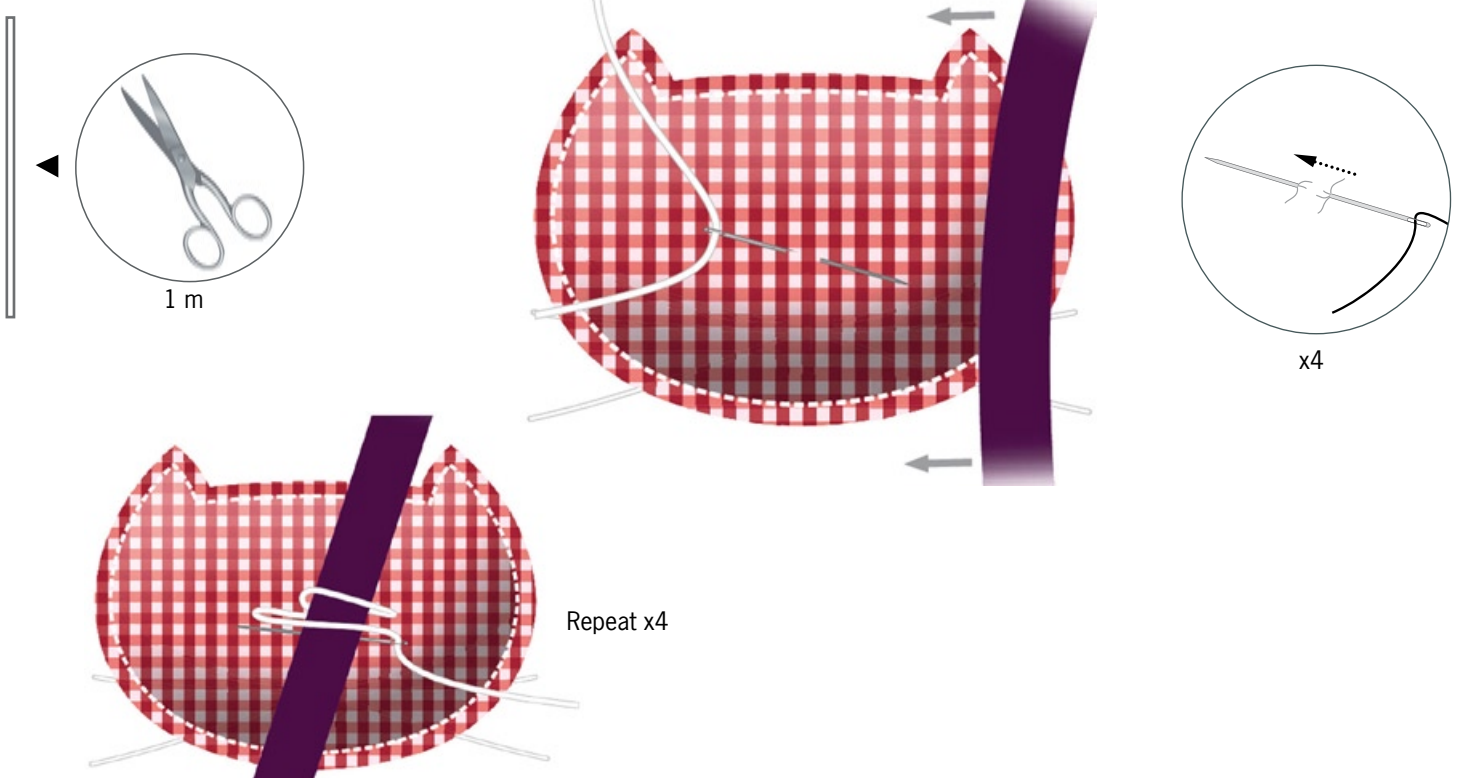

STEP 12: Finish with 4 back stitches as you see below then cut off the remaining thread.

